

# Jay Series, Select, Baja, J/Trax

Built Better.

2007 Camping Trailers by Jayco®



Jay Series | Select | Baja | J/Trax | 2007 Camping Trailers



AMERICA'S MOST LIVEABLE RVs.



AMERICA'S MOST **LIVEABLE** RVs.

"Liveable" may mean what you see, what you feel or even what you trust about a Jayco. But one thing is for certain, "liveable" is the reason why more people across North America are making Jayco their choice in RVs.



Jay Series™



## Invisible Liveables

Camping simplified is what folding camping trailers are all about. Jayco believes owning one should be simple as well. Jayco's fully enclosed, patented lifter system means reliable quality with no rust, no dirt build-up and no surprises when you unfold season after season. Jay Series, Select, Baja and J/Trax all mean built better.

### Jayco's Patented, Fully Enclosed Roof Lifter System

- a. Jayco uses tubular lifter posts instead of C-channels. They have smooth walls and no edges to chafe or soil the tent with grease. They also have no openings. Fingers can't get inside, eliminating the chance of injury!
- b. Stop worrying about cables or pulleys getting caught in lifter posts. Strong flexible steel push-rods guide the roof up as you crank.
- c. For years of trouble-free operation, Jayco camping trailers use nylon bushings in the lifter posts. This reduces friction, wear, and tear.
- d. The automatic brake on our lifter system winch helps prevent the roof from falling before it's all the way up so it's OK to take a break while cranking.
- e. Our lifter system crank is set at an ergonomic height. You don't have to bend way over or scrape your knuckles to use it. We also made it easier to turn, so setup is a cinch.
- f. The roof-lifter system on all Jayco camping trailers is fully enclosed above the floor. This eliminates damage to parts from road debris and weather as a result of transit—a common problem with competitors' underfloor-mounted lifter systems. It also eliminates rodent or insect access points found where competitors' cables pass through the floor.

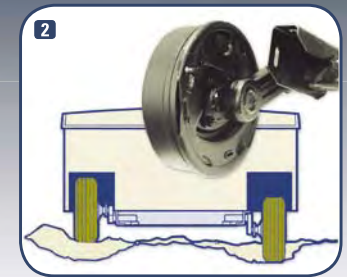
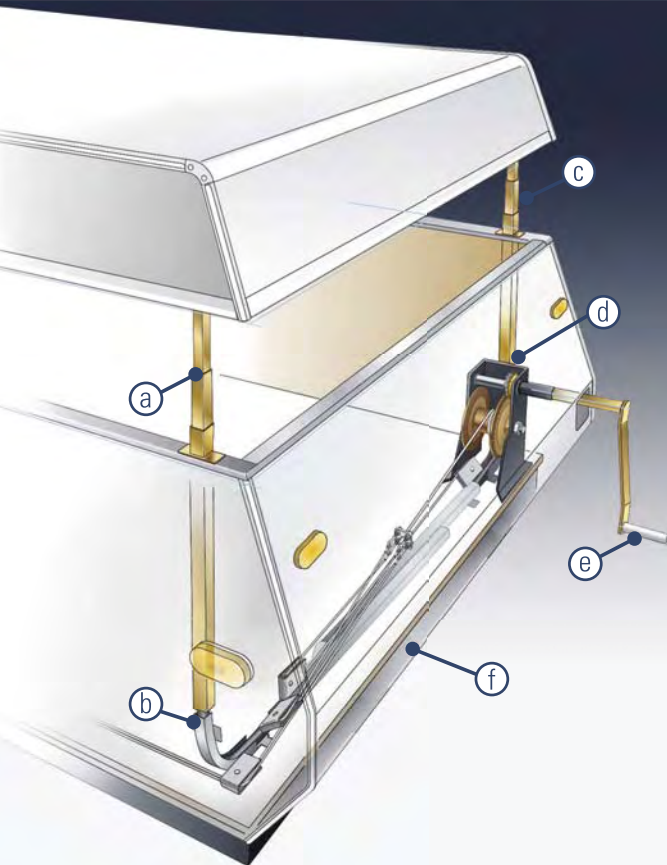



1. Frames protected from corrosion by 12-stage E-Coat™ finishing system
2. TorFlex® torsion-axle suspension simplifies towing (available only on Select camping trailers)
3. Single-piece Structurwood® floor is undercoated and edge-sealed to repel moisture
4. One piece tents with unique Velcro® tent-to-bunk attachment system for superior strength
5. Plywood construction
6. Domed fiberglass roof built with no center seam for better water runoff
7. Crank-down stabilizer jacks with sand pads
8. One-piece fiberglass exterior sidewall
9. Rounded one-piece high-density polyethylene wheel wells
10. 1/8" luan board
11. EZ Lube® axles make maintenance a snap
12. Retractable, skid-resistant double step (optional on J/TRAX)
13. One-piece entrance door
14. Undercoated floor constructed of edge floor Structurwood™
15. Easy-care vinyl flooring, wall to wall
16. Spills are no problem on reversible vinyl dinette cushions
17. Heavy duty A-frame construction
18. One-piece extruded aluminum bed frame
19. Plywood decking
20. White powder coated bed bow
21. Rugged diamond-plate panels used on front and rear endwalls (N/A on J/TRAX)
22. Jayco's old-world Amish craftsmen build RVs with the same tried-and-true construction methods used for generations
23. Comfortable Jay Series interior enhances your camping experience

## Incredible Liveables.

The high-walled Select brings space to the camping trailer. Space for larger refrigerators, full ranges with microwaves and more headroom. Select also means more storage space inside and outside.

**Select™**  
Premium Camping Trailer



Jayco's new recessed stainless steel range/sink combo is a real space saver when it comes to meal preparation.



The RVQ®, Jayco's optional portable gas grill, attaches quickly whenever your family is ready for a cookout.



Keep food items cold and fresh (without depending on coolers) with this handy 3-cu. ft., 3-way refrigerator.



Lockable storage trunk gives you a spot for large items and helps keep your living space clutter-free.

## Off-Roadable Liveables.



Thirteen inches of ground clearance and heavy-duty suspension gets you where you want to go. The front Bike Port™ deck, with 1200-lb. weight capacity, holds 2 bikes or an ATV to use when you get there. Hunting, fishing or just off roading... with Baja, you've got your base camp.

**BAJA™**  
Camping Trailer / Toy Hauler



After a busy day of fishing or 4-wheeling, relax in the comfort of the Baja's homelike living space.

10Y



Plug your iPod® into the dock and enjoy your favorite tunes with family or friends on the built-in stereo system.



Store your repair and maintenance tools in the optional diamond-plate toolbox.



For smoother trips, Baja camping trailers are built with leaf springs and shock absorbers.



## Affordable Liveables.

When sleeping on the ground gets old, J/Trax is your next move. All the comforts of RV camping while keeping cost and weight to a minimum. Options include air conditioner, refrigerator and even a furnace to extend your camping season. You could get used to this!

**J/TRAX™**  
Economy Camping Trailer



White laminate storage compartments provide room for all your essentials and a clean, contemporary look.



Enjoy the best of both worlds with the J/Trax – the simplicity and affordability of tent camping with the interior comforts of an RV.





Get off the ground and elevate your sleeping comfort with the three bunks inside the J/Trax. They can accommodate up to six.

treadlightly!®

OFFICIAL SPONSOR



Jayco proudly sponsors Tread Lightly!®, a nonprofit organization whose mission is to empower generations to enjoy the outdoors responsibly through education and restoration.

# Measurable Liveables.

## Customer Value Package

- 2-cu.ft. 3-way gas/electric refrigerator (110V/12V/Propane)
- 7-spoke polished aluminum wheels
- AM/FM stereo and CD player
- Battery gauge
- 1 Bunk-end fan lights (2)
- iPod® adapter
- Prep for solar power
- Self-storing awning made by Jayco®
- Water purification system



## Standard Exterior Equipment

- 12" C-range tires (806, 1007)
- 13" C-range tires (1006, 1207, 1206)
- 14" D-range tires
- 14" x 14" roof vent
- 15" off-road Dunlop® Mud Rover radial tires
- 15" black steel rims
- 20-lb. propane gas bottle
- 110V G.F.C.I. protected exterior receptacle
- Bumper made with welded steel construction
- Camper-Tex™ water-repellent one-piece vinyl tent
- Cast aluminum 110V G.F.C.I. protected exterior receptacle
- Crank-down stabilizer jacks with sand pads
- Crank-down stabilizer jacks
- Diamond-plate walls on front and rear
- Domed, fiberglass roof with no center seam
- Double aluminum exterior sidewalls
- Double entrance step
- E-Coat™ protected frame
- Electric brakes (Jay Series 1206 only)
- Entrance door access with roof lowered
- Entrance door is 1-piece construction
- Entrance door caddy
- Exterior entrance door storage
- Extrusions for box top are painted (powder-coated) black with black corner caps
- Extrusions for box top are painted (powder-coated) white with white corner caps
- Entrance step prep
- E-Z Lube® axles
- Floor is undercoated and constructed of edge-sealed Strukturwood™
- Front storage deck with expanded steel surface and aluminum deck railing
- Jayco's original, fully enclosed lifter system (same design used since 1968)
- Leveling jacks and heavy-duty A-frame construction
- Lifter post covers
- Light in front trunk
- Moto graphics
- Mud flaps
- One-piece high-density polyethylene wheel wells
- Outside shower (N/A 806)

- Patio light with amber lens
- Prep wiring for battery
- Ramps / deck railing (dual use)
- Rear bumper made of 4" tubular steel
- Rounded wheel wells
- Rubber truck-type fenders
- Scratch resistant, embossed aluminum finish on exterior
- Self-storing screen door
- Self-storing step
- Shock absorbers (racing yellow)
- Silver wheel rims
- Spare tire and tire carrier
- Spare tire prep
- Storage compartment in front trunk (Select models)
- Tor-Flex® independent torsion axle suspension
- Tent attachment velcros around entrance door
- 2 Vinyl, spare tire cover
- Wide-body construction



## Standard Heat, Power and Water

- 12V electrical system with 30-amp. 110V converter
- 12V electrical system with 20-amp. 110V converter
- 12V electrical system with 12-amp. 110V converter
- 3 17 gal. fresh water system with 12V demand pump
- 16,000 BTU Furnace
- 30ft 30 amp power cord
- Double 20-lb. gas bottles, with vinyl cover
- Hookup for city water
- Porta-potti storage cabinet (N/A 806, 1207)



## Standard Interior Equipment

- 4" bed mats
- 110V G.F.C.I. protected interior receptacle
- 12V high-intensity lighting
- Automatic cut-off switch for interior lights
- Bar for hanging clothes
- Bed flaps that cover edge of bed
- Black cabinet hardware
- Black linoleum
- Booth dinette
- Bunk end fan lights (2)
- Brushed nickel hardware
- C-clamp connection on tent supports
- Cable TV hookup with RG6 connection
- Coordinated furniture, designed and made by Jayco®
- Cup holders in the booth and sofa (1206)
- Door pulls with roller catch
- Drawers are made of real wood with nylon guides
- Floor-level courtesy lights
- Granite-look countertop
- Hinged dinette seat bases
- J-Steel™ sofa (1006, 1206)
- Manchester Oak raised panel cabinetry

- Mildew resistant aluminum ceiling
- Modern interior designed and made by Jayco®
- Non-sliding, 4" deep cushions for dinette with reversible EZ-clean™ vinyl backs
- Powder-coated white bunk end bows with adjustable tension tent supports
- Prep for A/C
- Privacy curtains for end-bunks
- SoftShade™ window shades and valances
- Table extension
- Tinted vinyl windows
- Vinyl flooring wall to wall

## Standard Kitchen Equipment

- 3-cu.ft. 3-way gas/electric refrigerator (110V/12V/Propane)
- 6-gal. water heater (N/A 806)
- Appliances are pre-plumbed for propane
- Carry-out dinette table
- Fluorescent light above sink
- Recessed stainless steel sink/range combination with hinged glass top
- Spice rack
- Stainless steel sink and faucet
- Stainless steel carryout stove (2-burner depending on model)
- Tray for silverware

## Standard Safety Equipment

- 1200 lb. front deck capacity
- Breakaway switch
- Carbon monoxide detector
- Dual hitch safety chains
- Fire extinguisher
- Propane gas leak detector

## Optional Equipment

- 16,000 BTU furnace with auto-ignition
- A/C prep and refrigerator package
- Bath/Shower
- Canopy
- Convection microwave
- CSA Standards
- Customer Value Package
- Deluxe screen room
- Drawer for exterior storage
- Electric brakes (standard for 1206)
- Extra table with pedestal leg (1007, 1207)
- Front storage box
- 4 Heated bed mats (2)
- Hydraulic surge brakes
- Portable, outside gas RVQ® grill with carrying case
- Powered attic fan in bathroom
- Spare tire w/carrier
- U-Dinette



## 2007 Specifications and Measurements

	Travel Length	Campsite Length	Approximate Travel Height	Unloaded Vehicle Weight	Approx. Hitch Weight	Gross Vehicle Weight Rating	Cargo Carrying Capacity	Fresh Water Capacity	Sleeping Capacity	
Jay Series	806	11' 10"	16' 2"	53"	1395	170	2000	605	17	5-6
	1006	16' 9"	20'	56"	1920	180	2950	1030	23	6-8
	1007	14' 2"	20' 4"	54"	1555	170	2300	745	23	6-8
	1008	16' 3"	20' 10"	56"	1880	165	2950	1070	23	6
	1206	18' 9"	22' 10"	56"	2380	305	3450	1070	23	6-8
	1207	16' 2"	23' 4"	54"	1870	190	2950	1030	23	6-8
Select	12HW	18' 9"	22' 10"	63"	2695	280	3750	1055	23	5-6
Baja	10Y	19' 5"	20' 10"	66"	2375	220	4550	2175	23	4-6
J/Trax	801	11' 10"	16' 3"	53"	1135	150	1795	660	-	5-6
	1202	16' 2"	12' 10"	57"	1415	150	2210	795	-	4

It is important for your safety and enjoyment that your tow vehicle be adequately sized and equipped to tow and handle the GVWR of the RV you select. Review weights and rating of your tow vehicle and consult a competent advisor for questions or advice. Whether you are new to RVing or a veteran, get a feel for the performance of your tow vehicle and the RV together before heading out on the roadways. When you tow an RV, you must drive differently than you do when driving a single vehicle. Practice hooking up, driving, backing up, and braking in a safe environment or seek out professional instruction. Jayco affixes a weight label to each RV which lists weight information for that vehicle. See specification chart on the left. This chart is for guidance only, specifications may vary.

**Unloaded Vehicle Weight (UVW):** Sometimes referred to as "Dry Weight," UVW means the typical weight of this trailer as built at the factory. The UVW, as used in product literature and other promotional materials, does not include cargo, fresh water, propane, options, or dealer-installed accessories.

**Gross Vehicle Weight Rating (GVWR):** GVWR means the maximum permissible weight of the trailer, including the UVW plus passengers, personal items, all cargo, fluids, options, and dealer-installed accessories. The GVWR is equal to or greater than the sum of the UVW and the CCC.

**Cargo Carrying Capacity (CCC):** CCC means the maximum weight of all passengers, personal items, food, fresh water, propane, tools, other cargo, and dealer-installed accessories that can be carried by the trailer. CCC is equal to or less than GVWR minus UVW. The addition of options will decrease the CCC.

**Hitch Weight (HW):** The hitch weight, as used in product literature and other promotional materials, does not include cargo, fresh water, propane gas, options or dealer-installed accessories. The addition of these types of items will either add to or subtract from the stated hitch weight.

# Available Liveables.

## 2007 Jay Series

806

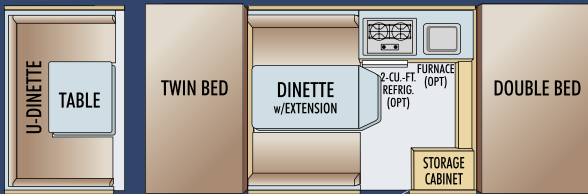

U-DINETTE OPTION

CARRYOUT STOVE

1006

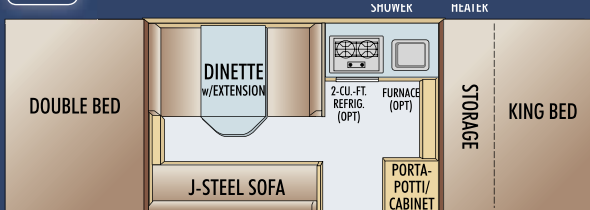

CARRYOUT STOVE

1007

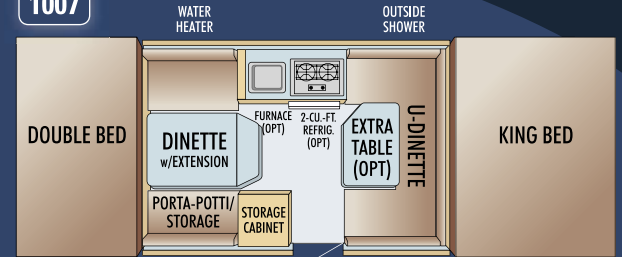

CARRYOUT STOVE

1008

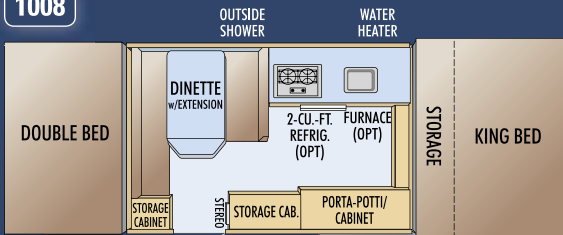

CARRYOUT STOVE

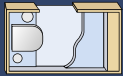

BATH/SHOWER OPTION

1206

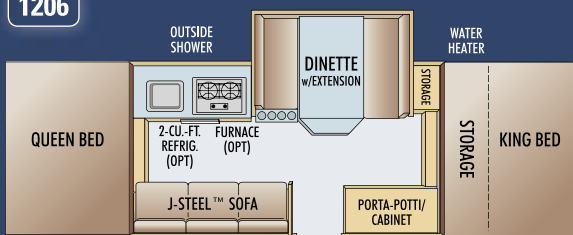

CARRYOUT STOVE

BATH/SHOWER OPTION

1207

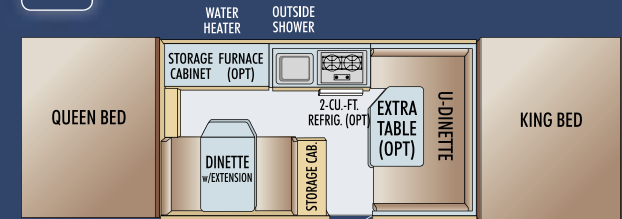

CARRYOUT STOVE

## 2007 Select

12HW

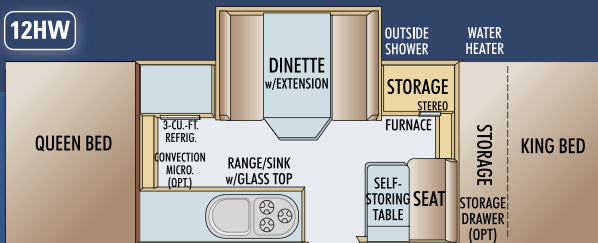

BATH/SHOWER OPTION

## 2007 Baja

10Y

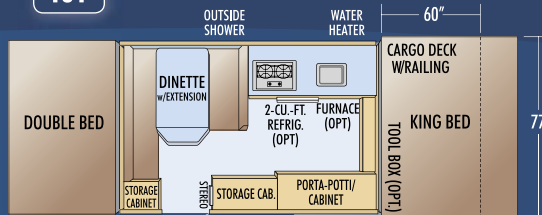

CARRYOUT STOVE



BATH/SHOWER OPTION

## 2007 J/Trax

801

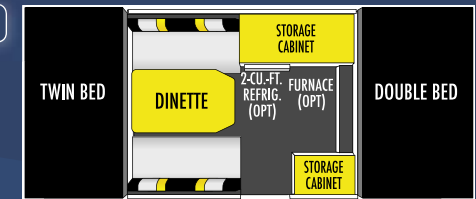

1202

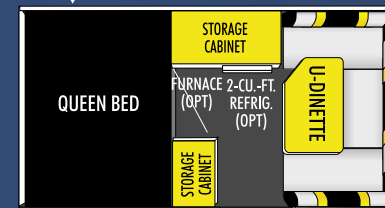



## We Back What We Build.

The Jayco Co-Pilot Warranty is a manufacturer's limited warranty. It comes from the people who build Jayco recreation vehicles to the people who buy them. Each Jayco is warranted to the original purchaser for twenty-four (24) months or twenty-four thousand (24,000) miles (mileage limitation applies to motorized products only), whichever occurs first, from the original date of purchase against defects in materials and workmanship. In addition, our limited warranty may be transferred one time within the warranty period. Go ahead and compare the Jayco warranty with other manufacturers' warranties. You'll find it's the best in the business!

Jayco offers the original purchaser additional industry-leading lifetime parts and labor coverage on our lifter system, roof, floor, and frame. We also offer five-year (5) coverage on our tent with parts, labor, and freight covered the first two years; parts, factory labor, and return freight during years, three, four, and five.

### Lifetime Coverage.



For a copy of the limited warranty with full terms and conditions, ask your local Jayco dealer or visit our website at [www.jayco.com](http://www.jayco.com).

### Customer First Roadside Assistance

Travel worry-free with your camping trailer with Jayco's Customer First Roadside Assistance program, yours at no cost during your first year of ownership. This program is offered through Coach-Net®, the largest RV emergency road service in the country, and gives you immediate access to dependable roadside assistance and support services with a simple phone call.

- 24-hour toll-free emergency message service
- Toll-free nationwide service appointment assistance
- Free custom trip routing and full color map service
- Free dispatch of on-site mechanical service
- \$1,000 auto theft or hit-and run reward
- \$2,000 trip interruption reimbursement
- Free jump starts
- Free tire changes
- Free fuel delivery
- Free lockout service
- Free travelers checks



AMERICA'S MOST LIVEABLE RVs.

Jayco, Inc., P.O. Box 460, Middlebury, IN 46540 [www.jayco.com](http://www.jayco.com)



Your Jayco Dealer



Protect your RV investment. Ask your Jayco dealer about our exclusive JayPlus program today.



As a Jayco owner, you can be part of the Jayco Jafari International Travel Club. Ask your dealer about the Jafari "flight" in your area, write Jayco, or visit our website.

See dealer for further information and prices. All information in this brochure is the latest available at the time of publication approval. Jayco reserves the right to make changes and to discontinue models without notice or obligation. Photos in this brochure may show optional equipment or props used for photography purposes. RVs built for sale in Canada may differ to conform to Canadian codes. RVQ is a registered trademark of Vitco, Inc. E-Z Lube is a registered trademark of the Dexter Axle Company. Carefree is a registered trademark of Carefree of Colorado. Dolby and the double-D symbol are registered trademarks of Dolby Laboratories. ©2007 Jayco, Inc. 07-FDCT-PL 0107-50K Printed in U.S.A.